

LUXMAN

COMPACT DISC PLAYER
D-03X

Luxman
COMPACT DISC PLAYER D-03X

COMPACT
DIGITAL AUDIO
DSD

DIGITAL
IN

PHASE
INVERT

R

DIGITAL
OUT

PHASE
INVERT

MOA

TRK
1
9:25

Timeless design meets cutting edge technology



Now a single digital player embodies the most advanced digital decoding along with the most enduring approaches to design and engineering.

LUXMAN's new D-03X combines traditional red-book CD playback with an advanced hi-res DAC circuit featuring MQA full decoding.

Of crucial importance, the D-03X inherits the philosophy and experience of successive LUXMAN digital players and remains true to timeless LUXMAN design principles, including rugged chassis, oversized power supply and meticulous circuit selection. The result: reproduction of effortless musicality.

Highly advanced digital decoding

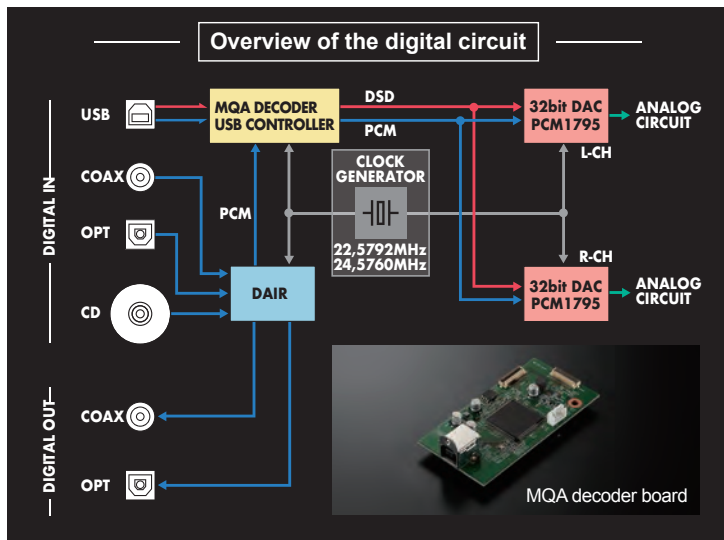

The D-03X can reveal new subtleties in even the most familiar music. MQA (Master Quality Authenticated) is an award-winning British technology that delivers the sound of the original master recording. The player includes MQA technology, which enables you to play back MQA-CDs as well as MQA audio files up to 24-bit transferred via USB, optical and coaxial inputs. The USB input also supports PCM data up to 384 kHz/32-bit and DSD data up to 11.2 MHz while the optical and coaxial inputs accept PCM signals up to 192 kHz/24-bit. In addition to conventional "isochronous" file transfers at fixed bitrates, the USB input supports four modes of Bulk Pet™ high-resolution audio file transfer. Bulk Pet, optimizes data packaging and delivery to the DAC easing the processing load for both the host CPU and the device CPU enhancing playback stability and ultimately yielding improved sound quality. All signals benefit from a high-precision, low-jitter, low-phase-noise master clock, minimizing noise near the oscillation frequency and optimizing transmission accuracy.

*Bulk Pet is a registered trademark of Interface Co., Ltd.

Display with zoom mode



LUXMAN's zoom mode makes the fluorescent display easy to see from a distance. In addition, a multi-colored LED indicates MQA decode status (blue for Studio, green for Authentic, and purple/red for Renderer).

Aluminum remote control

The supplied aluminum remote control has the same blasted aluminum white finishes the front panel. You can use the numeric keypad, transport controls and display dimmer without moving from the ideal listening position.

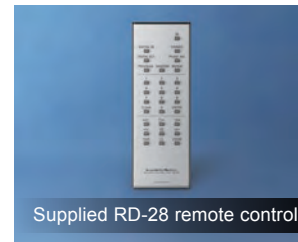

LUXMAN's original playback software



For playing back music from a personal computer, we recommend our LUXMAN Audio Player application. Available for Windows and Mac systems, the software enables superlative USB output of FLAC, ALAC, WAV, AIFF, MP3 and DSF/DSDIFF files. (You can download the application from the official LUXMAN website.)

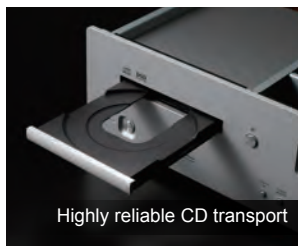

Rugged CD transport with steel top plate

The CD transport mechanism achieves uncommonly stable playback with a steel top plate, an 8mm thick solid aluminum base, a shielded box sub chassis and a loop-less structure. Undoubtedly expensive, these advances achieve uncommonly smooth, accurate and quiet disc read.

Dual Monaural D-to-A converters

LUXMAN engineers selected a pair of Texas Instruments 32-bit PCM1795 digital-to-analog converters to process digital signals with remarkable precision. Separating left and right channel conversion helps reveal the subtlest micro-dynamics.



Full complement of inputs and outputs

Full complement of inputs and outputs To support the widest range of associated equipment, the D-03X provides 8mm pitch gold-plated RCA outputs and high-end Neutrik™ balanced XLR outputs. The USB input supports DSD and PCM signals, while the player offers coaxial and optical digital inputs and outputs.



Oversized power supply

For superbly stable voltage, the D-03X incorporates a massive power transformer, independent regulators for each circuit and large capacity filter capacitors. To minimize even subtle effects from magnetic fields, ground impedance and digital noise, the chassis is loop-less and shielded.

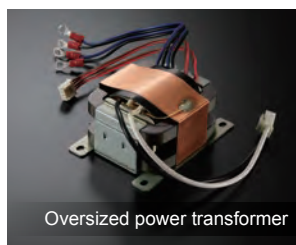

Engineered in every aspect

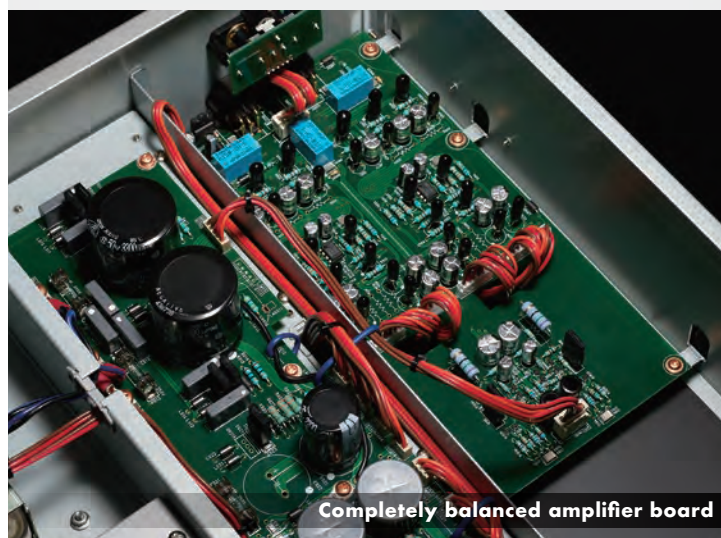

At LUXMAN, we matched the meticulous disc transport and digital design of the D-03X with a thoroughly engineered chassis and analog output stage. The asymmetric mechanical layout places the CD drive at the left – ideal for signal flow, resonance control and weight balance. Our robust box chassis frame shields the CD transport and delicate circuitry from external vibrations and noise. For the all-important analog circuit, we feed the outputs of the dual monaural digital-to-analog converters to a current-to-voltage converter stage. The following stage low-pass filter amplifier benefits from low impedance. Fully balanced outputs featuring Neutrik XLR connectors complement conventional RCA output terminals. LUXMAN's unwavering attention to detail contributes to ultimate listening enjoyment.

D-03X COMPACT DISC PLAYER

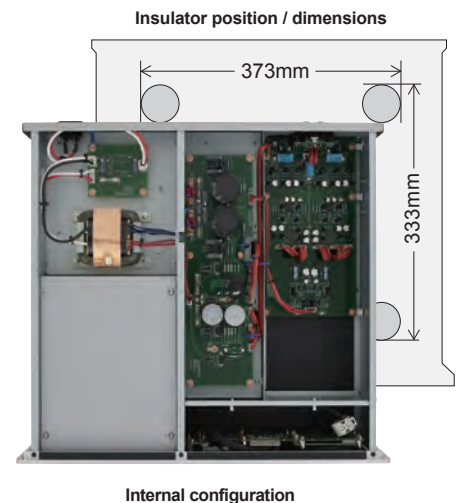
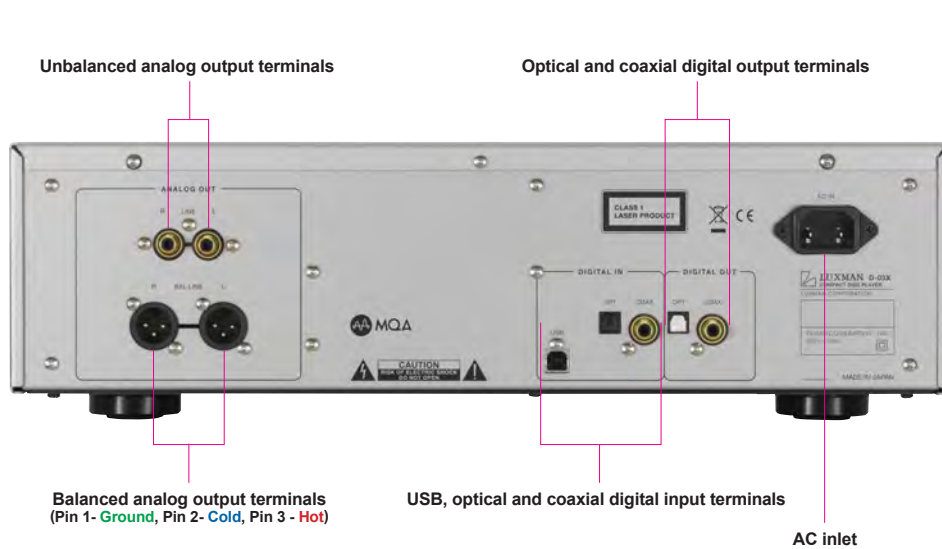
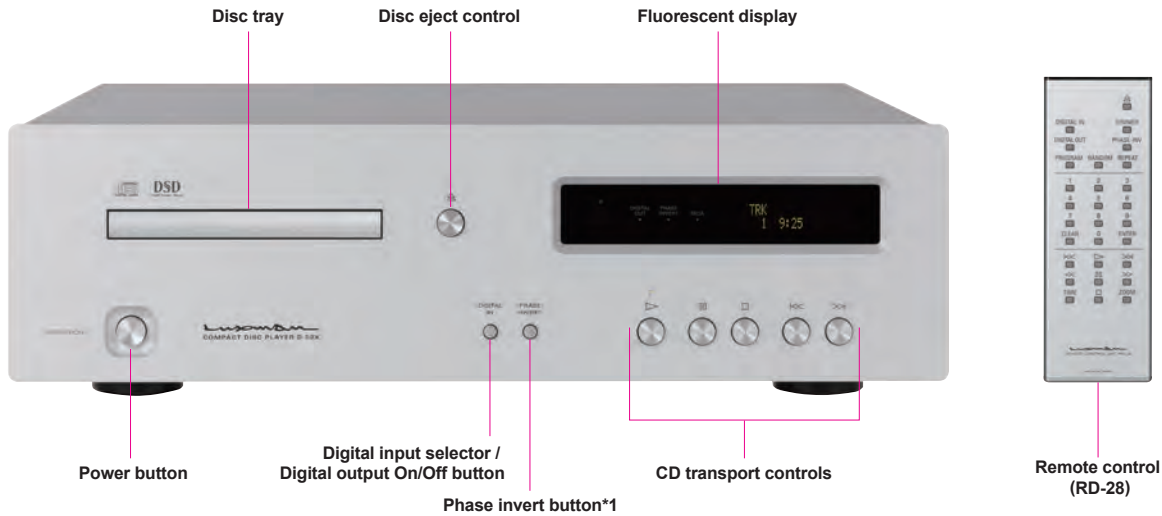

SPECIFICATIONS

Supported discs	CD (CD-R, CD-RW, MQA-CD)
Supported sampling frequencies	USB input (PCM) : 44.1 kHz, 48 kHz, 88.2 kHz, 96 kHz, 176.4 kHz, 192 kHz, 352.8 kHz, 384 kHz (16, 24, 32-bit) USB input (DSD) : 2.8 MHz, 5.6 MHz, 11.2 MHz (1-bit) Coaxial / Optical input : 44.1 kHz, 48 kHz, 88.2 kHz, 96 kHz, 176.4 kHz, 192 kHz (16, 20, 24-bit)
Analog output voltage / impedance	Unbalanced : 2.4 V / 300 Ω, Balanced : 2.4 V / 600 Ω, DSD : 1.7 V
Frequency response	CD : 5 Hz to 20 kHz (+0, -1.0 dB) Coaxial / Optical : 5 Hz to 47 kHz (+0, -3.0 dB) USB : 5 Hz to 47 kHz (+0, -3.0 dB)
Total harmonic distortion	CD : 0.003 %, Coaxial / Optical : 0.002 %, USB : 0.002 %

S/N ratio (IHF-A)	CD : 101 dB, Coaxial / Optical : 114 dB, USB : 113 dB
D/A converter	Texas Instruments PCM1795 (monaural mode) x 2
Power supply	230 V~(50 Hz) / 115 V~(60 Hz)
Power consumption	18W
Dimensions	440(W) x 133(H) x 410(D) mm front side knob of 2 mm and rear side terminal of 8 mm included in depth
Net weight	13.2 kg
Accessories	Remote control (RD-28), Power cable

*1 Pressing the phase invert button allows balance output terminal No.2 to change HOT, and No.3 to COLD.
*LUXMAN Audio Player software for Windows 10 and macOS 10.15 and driver software for Windows can be downloaded from the LUXMAN website.
*Mac, Mac OS, OS X and macOS are trademarks of Apple Inc., registered in the U.S. and other countries. Windows is a registered trademark of Microsoft Corporation in the United States and/or other countries.
*DSD is a trademark. *MQA and the Sound Wave Device are registered trade marks of MQA Limited.(c) 2016
*MQA-CD is a registered trade mark of MQA Limited.(c) 2017 *The described company names and product names are trademarks or registered trademarks of each company.

LUXMAN

LUXMAN CORPORATION, 1-3-1 Shinyokohama, Kouhoku-ku, Yokohama-shi, Kanagawa 222-0033, Japan
Tel: +81-45-470-6980 Fax: +81-45-470-6997 www.luxman.co.jp
LUXMAN reserves the right to alter the design and specifications without notice.
All rights reserved LUXMAN CORPORATION



⚠ Safety Cautions

To ensure correct use of this product, read the "Owner's Manual" prior to use. Failure to follow all safeguards can result in fire, electric shock, or other accidents.