

LUXMAN

SUPER AUDIO CD PLAYER
D-07X



Inheriting LUXMAN's outstanding flagship pedigree

A new class of digital media player

Many of the audio formats available today are undergoing a transformational period.

By providing digital circuitry that supports advanced, high resolution file formats and the latest DAC environment, this model brings out unprecedented excitement from CDs and SACDs, which are still in an important position as audio media.

The D-07X inherits the luxurious styling and outstanding performance of our flagship model, the D-10X. This advanced digital media player delivers overwhelming performance.

It truly conveys the ambience and feeling of recorded music over a wide range of media, delivering the finest listening experience.



Advanced DAC circuitry, reproducing digital media with excellent sound quality

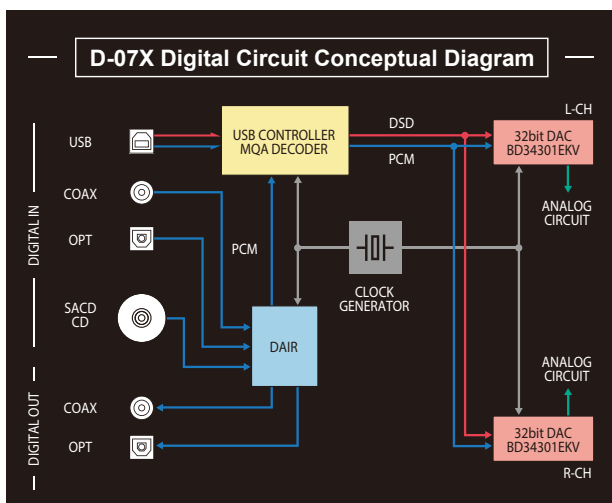

Following standards set by our D-10X flagship model, high-end BD34301EKV DAC chips manufactured by Rohm Co., Ltd. in dual monaural configuration lie at the core of the digital circuitry that processes various digital media from discs, such as CDs and SACDs, to the latest high resolution audio files with exceptional quality. Over a USB input from a PC, Mac, NAS for audio, etc., the D-07X supports a wide range of format encoding up to PCM768kHz/32 bit and DSD22.4MHz. Bulk Pet transfer, which equalizes transmission load, can also be selected by using our dedicated driver software. Furthermore, for the popular high-quality format MQA (MQA-CD/MQA file), which expands the field of optical discs, streaming USB, COAX, and optical. The clocking system is designed to support accurate digital signal processing and is equipped with two high-precision, low-jitter, ultra-low phase noise modules that reduce noise near the oscillation frequency to a minimum. There is also a built-in, 2-mode analog FIR filter that allows you to select your preferred sound quality when playing SACD or DSD files.



ROHM DAC chips



MQA decoder board

Highly pure signal transmission from file reading to analog output



Highly robust LxDTM-i drive mechanism

The D-07X employs a left-side mechanical layout with an asymmetric configuration that realizes the shortest and ideal audio signal path and affords space for high quality analog circuitry. The disc drive section that supports CD and SACD playback is based on our original, highly robust LxDTM mechanism, which features a robust box structure that covers the entire mechanism with a side frame and top plate. Our LxDTM-i* system has evolved into an integrated structure that firmly blocks external vibration by being mounted directly onto the strong chassis side panel, achieving high precision and stable signal reading performance, comparable to our D-10X flagship model. The disc tray is made of die-cast aluminum, eliminating unnecessary vibration and resonance effects on the loader mechanism and enabling precise and smooth loading operation.

*LxDTM-i is an abbreviation for Luxman original Disc Transport Mechanism-improved, which realizes stable signal reading and mechanical integrity.

Newly developed discrete buffer circuitry

As a component that handles digital sources, high-precision signal reading by the drive mechanism and advanced digital signal processing are very important, but it goes without saying that the high performance analog output circuitry which determines the final audio quality is the most important factor in realizing that deep musical expression expected from high-end components designed by LUXMAN. The D-07X has a newly developed I/V conversion system that receives the differential outputs of the paired BD34301EKV DAC chips, operating in monaural mode, and feeds four discrete, perfectly matched amplifier modules. High-quality buffer circuitry lowers the impedance of the output signal. The unit powerfully drives any integrated amplifier or control amplifier that would be the next stage component. Out-of-audible-range filtering, which is essential for digital players, is performed in the buffer stage instead of having an independent LPF stage, enabling the reproduction of natural and smooth analog waveforms, resulting in higher clarity and more immediate sound quality.

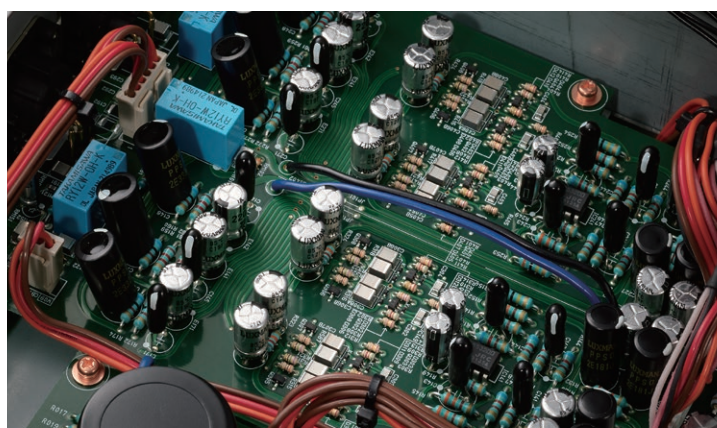

Discerning technology, pursuing musicality, functionality and enhanced convenience

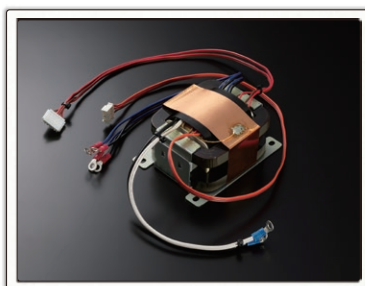

Large-capacity power supply

The D-07X's power transformer capacity has been increased by 50% compared to our D-06u model. Large capacity filter capacitors and independent regulator blocks have been installed for each circuit to develop a highly stable overall power supply environment traditional to LUXMAN. Again, clean and stable power has been achieved.



Discerning original technologies and construction

The D-07X is housed in a shielded chassis structure, insulating its various signal paths from interference and digital noise. The density gradient of its cast iron legs, firmly bearing the weight of the main body, protect delicate musical signals from external vibrations transmitted through the supporting surface. Internal damping countermeasures eliminate unnecessary vibrations generated within the unit itself.

Abundant input / output terminals

The analog outputs are equipped with both 32mm pitch, gold-plated RCA terminals and newly adopted, Neutrik shielded XLR terminals. Abundant digital connectivity features a USB terminal that supports PCM/DSD input, with coaxial and optical input terminals that support PCM formats up to 192kHz/24bit, and coaxial and optical output terminals.



External interlocking terminal to expand the function

The D-07X is newly equipped with trigger input/output terminals for linking remote control signals between corresponding LUXMAN products.

*Connection cable is not included. Please source a 3.5mm monaural jack cable. We hope to develop control terminal support via wireless remote operation as an option in the future.



Display with excellent visibility

The FL display with excellent visibility that shines on the delicate panel of blaster white finish is equipped with a 4x zoom display mode that is easy to see even from a distance. When playing the MQA format, the decoding status (Studio: Blue, Authentic: Green, Renderer: Magenta) is displayed by a three-color LED indicator.



AC inlet and power cable

The AC inlet's structure has been improved to support the weight of heavy power cables by reversing the mounting, suppressing any movement of the power cable while maintaining a stable grip.

D-07X SUPER AUDIO CD PLAYER

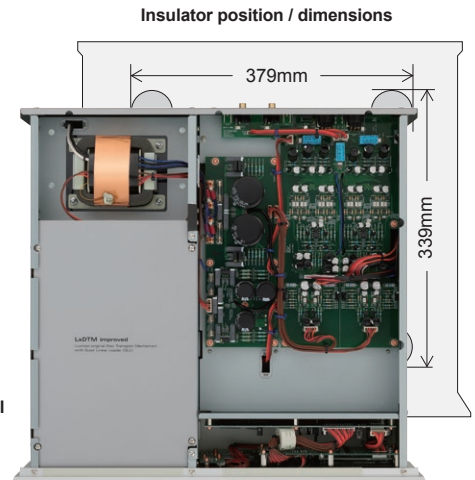
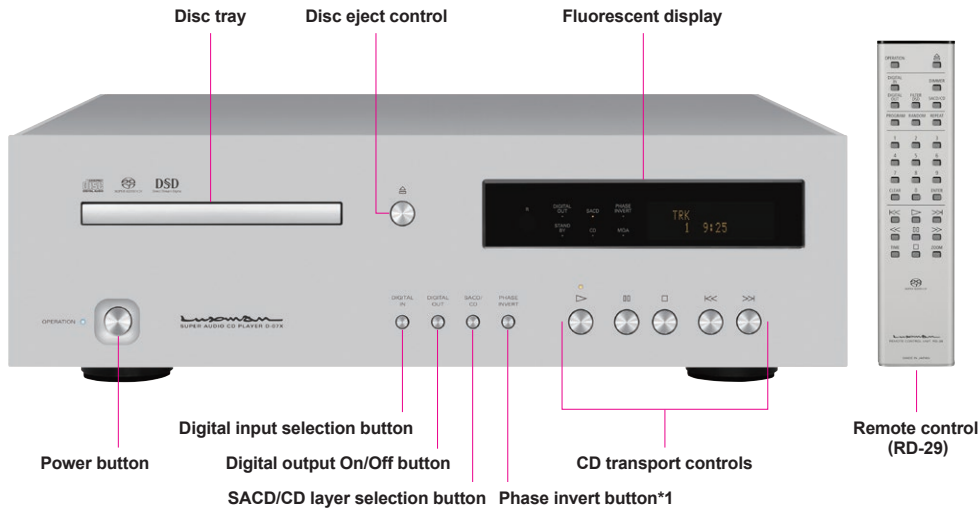

Internal configuration (Upper side)

Balanced analog output terminals (Pin 1 - Ground, Pin 2 - Cold, Pin 3 - Hot) Unbalanced analog output terminals

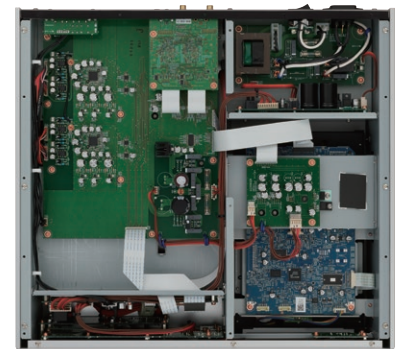
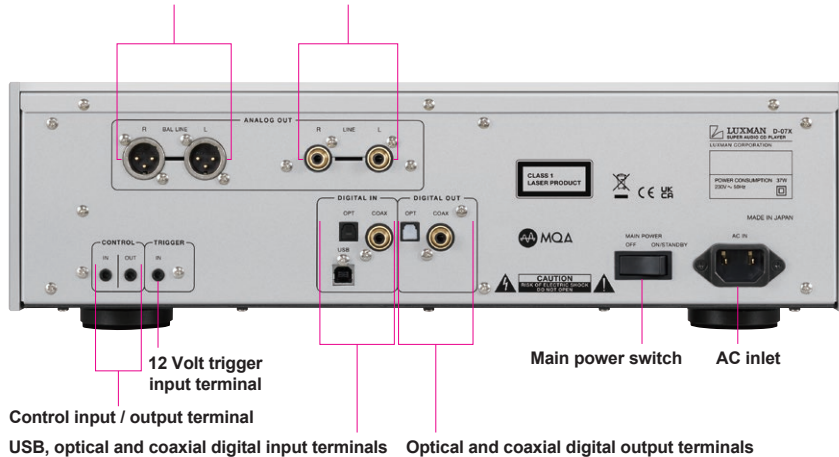

Internal configuration (Bottom side)

SPECIFICATIONS

Supported discs	SACD, CD (CD-R, CD-RW, MQA-CD)
Supported sampling frequencies	USB input (PCM) : 44.1 kHz, 48 kHz, 88.2 kHz, 96 kHz, 176.4 kHz, 192 kHz, 352.8 kHz, 384 kHz, 705.6 kHz, 768 kHz (16, 24, 32-bit) USB input (DSD) : 2.8 MHz, 5.6 MHz, 11.2 MHz, 22.4 MHz (1-bit) Coaxial / Optical input : 44.1 kHz, 48 kHz, 88.2 kHz, 96 kHz, 176.4 kHz, 192 kHz (16, 20, 24-bit)
Analog output voltage / impedance	Unbalanced : 2.4 V / 300 Ω, Balanced : 2.4 V / 600 Ω For SACD / DSD : 2.3 V
Frequency response	CD : 5 Hz to 20 kHz (+0, -1.0 dB) SACD : 5 Hz to 38 kHz (+0, -3.0 dB) USB : 5 Hz to 47 kHz (+0, -3.0 dB)
Total harmonic distortion	CD : 0.0016 %, SACD : 0.0007 %, USB : 0.001 %
S/N ratio (IHF-A)	CD : 122 dB, SACD : 125 dB, USB : 122 dB
D/A converter	ROHM BD34301EKV (monaural mode) x 2
Power supply	230 V ~ (50 Hz) / 115 V ~ (60 Hz)
Power consumption	37W
Dimensions	440(W) x 132(H) x 410(D) mm front side knob of 2 mm and rear side terminal of 8 mm included in depth
Net weight	17.0 kg
Accessories	Remote control (RD-29), Power cable

LUXMAN's original playback software

For playing back music from a personal computer, we recommend our LUXMAN Audio Player application. This software supports FLAC, ALAC, WAV, AIFF, MP3 and DSF/DSDIFF files. You can download the software for Windows and macOS from the official LUXMAN website.



*1 Pressing the phase invert button allows balance output terminal No.2 to change HOT, and No.3 to COLD.
*LUXMAN Audio Player (Windows 10 or newer / macOS 10.15 or newer) and driver software for Windows can be downloaded from our website.
*Apple Mac, Mac OS, OS X, macOS and Macintosh are trademarks of Apple Inc., registered in the U.S. and other countries.
*Microsoft and Windows is a registered trademark of Microsoft Corporation in the U.S. and other countries.
*MQA is a registered trade marks of MQA Limited.(c) 2018 *MQA-CD is a registered trade mark of MQA Limited.(c) 2017
*Bulk Pet is a registered trademark of Interface Co., Ltd.

LUXMAN

LUXMAN CORPORATION, 1-3-1 Shinyokohama, Kouhoku-ku, Yokohama-shi, Kanagawa 222-0033, Japan
Tel: +81-45-470-6980 Fax: +81-45-470-6997 www.luxman.com
LUXMAN reserves the right to alter the design and specifications without notice.
All rights reserved LUXMAN CORPORATION



⚠ Safety Cautions

To ensure correct use of this product, read the "Owner's Manual" prior to use. Failure to follow all safeguards can result in fire, electric shock, or other accidents.